



# + USER GUIDE

**VOGUE** SYSTEM  
S15 S18 S26 S32

June 2015 UIN 208551 A04

When replacing any part on this appliance, use only spare parts that you can be assured conform to the safety and performance specification that we require. Do not use reconditioned or copy parts that have not been clearly authorised by Ideal Boilers.



# Vogue System boiler

Natural Gas only

s15	G.C. Appliance No.	41-750-56
s18	G.C. Appliance No.	41-750-55
s26	G.C. Appliance No.	41-750-54
s32	G.C. Appliance No.	41-750-53

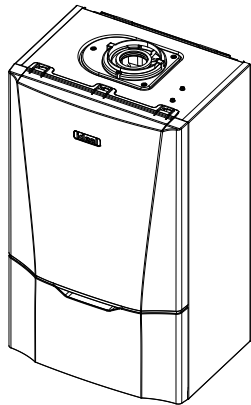

**Ideal Boilers** is a member of the Benchmark scheme and fully supports the aims of the programme. Benchmark has been introduced to improve the standards of installation and commissioning of central heating systems in the UK and to encourage the regular servicing of all central heating systems to ensure safety and efficiency.



**THE BENCHMARK SERVICE INTERVAL RECORD MUST BE COMPLETED AFTER EACH SERVICE**

**FOR ANY QUERIES PLEASE RING THE  
IDEAL CONSUMER HELPLINE : 01482 498660**

**NOTE. BOILER RESET PROCEDURE -**

To reset boiler, press button “r” on the control panel. The boiler will repeat the ignition sequence if a heat demand is present

**INTRODUCTION**

The **vogue** is a wall mounted, room sealed, condensing system boiler, featuring full sequence automatic spark ignition and fan assisted combustion.

Due to the high efficiency of the boiler, condensate is produced from the flue gases and this is drained to a suitable disposal point through a plastic waste pipe at the base of the boiler. A condensate ‘plume’ will also be visible at the flue terminal.

**SAFETY**

***Current Gas Safety (Installation & Use) Regulations or rules in force.***

In your own interest, and that of safety, it is the law that this boiler must be installed by a Gas Safe Registered Engineer, in accordance with the above regulations.

In IE, the installation must be carried out by a Registered Gas Installer (RGI) and installed in accordance with the current edition of I.S. 813 “Domestic Gas Installations”, the current Building Regulations and reference should be made to the current ETCI rules for electrical installation.

***It is essential that the instructions in this booklet are strictly followed, for safe and economical operation of the boiler.***

## IMPORTANT NOTES

- This appliance must not be operated without the casing correctly fitted and forming an adequate seal.
- If the boiler is installed in a compartment then the compartment MUST NOT be used for storage purposes.
- If it is known or suspected that a fault exists on the boiler then it MUST NOT BE USED until the fault has been corrected by a Gas Safe Registered Engineer or in IE a Registered Gas Installer (RGII).
- Under NO circumstances should any of the sealed components on this appliance be used incorrectly or tampered with.
- This appliance is not intended for use by persons (including children) with reduced physical, sensory or mental capabilities, or lack of experience and knowledge, unless they have been given supervision or instructions concerning use of the appliance by a person responsible for their safety.
- Children should be supervised to ensure that they do not play with the appliance.

In cases of repeated or continuous shutdown a Gas Safe Registered Engineer or in IE a Registered Gas Installer (RGII) should be called to investigate and rectify the condition causing this and carry out an operational test. Only the manufacturers original parts should be used for replacement.

## MINIMUM CLEARANCES

Clearances of **165mm (6 1/2")** above, **100mm (4")** below, **2.5mm (1/8")** at the sides and **450mm (17 3/4")** at the front of the boiler casing must be allowed for servicing.

### Bottom clearance

Bottom clearance after installation can be reduced to 5mm.

This must be obtained with an easily removable panel to provide the 100mm clearance required for servicing.

## BOILER CONTROLS

### LEGEND

- A. Boiler Status
- B. Exit Button
- C. Down Button
- D. Up Button
- E. Enter Button
- F. Reset Button
- G. CH Temperature Control
- H. On / Off Switch
- J. Burner On indication
- K. Pressure Gauge
- L. Boiler in Full Condensing Mode

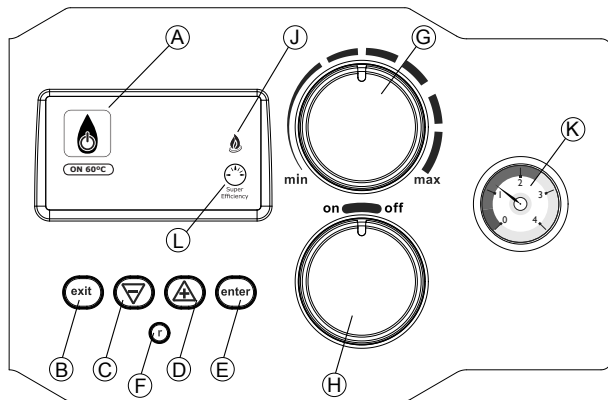

## TO LIGHT THE BOILER. (REFER TO BOILER CONTROLS)

If a programmer is fitted refer to separate instructions for the programmer before continuing.

1. Switch ON electricity to the boiler and check that all external controls, e.g. programmer and room thermostat, are ON.
2. Set the Central Heating temperature control (G) to 'max'.
3. Set ON/OFF switch (H) to ON.

The boiler will commence the ignition sequence supplying heat, if required.

**Note.** *In normal operation the boiler status display (A) will display the boiler operation mode.*

Boiler frost protection - boiler will fire if temperature is less than 5 degrees C.

During normal operation the burner on indicator (J) will remain illuminated when the burner is lit.

If the boiler has not lit, after 5 ignition attempts, the following screen will be displayed.

### **Ignition Lockout**

Check other Gas Appliances work  
If not, re-instate gas supply  
Reset boiler by pressing r  
If fault persists contact installer

Reset the boiler and the ignition sequence will be repeated.

## OPERATION

### Central Heating

With the external heating controls calling for heat, the ON/OFF switch (H) set to 'ON' and the CH Temperature Control (G) turned fully clockwise, the boiler will operate to provide heat to the system. Note this will also provide heat to the hot water system who's temperature will be controlled by the independent cylinder thermostat.

When the cylinder thermostat is satisfied the system valves will operate to direct all flow to the CH circuit. If the cylinder thermostat calls for heat the system valves will operate to circulate hot water around the cylinder to heat the stored water.

**Note.** *If the pump has not operated in the last 24 hours it will run briefly to ensure they do not become seized.*

The boiler controls the central heating radiator temperature to a maximum of 80°C, adjustable via the CH temperature control (G).

### WEATHER COMPENSATION

When the Weather Compensation option is fitted to the system then the CH Temperature Control (G) becomes a method of controlling room temperature. Turn the knob clockwise to increase room temperature and anti-clockwise to decrease room temperature. Once the desired setting has been achieved, leave the knob in this position and the system will automatically achieve the desired room temperature for all outside weather conditions.

### TO SHUT DOWN THE BOILER

Set the ON/OFF switch (H) to OFF.

### TO RELIGHT THE BOILER

Repeat the procedure detailed in 'To light the boiler'. Set the ON/OFF control to 'ON' and set the temperature control to between min & max.

## FROST PROTECTION

If no frost protection is provided and frost is likely during a short absence from home, leave the heating controls (if fitted) at a reduced temperature setting. For longer periods, the entire system should be drained.

If the system includes a frost thermostat then the timer can be left off (if fitted). The mains supply should be left switched ON, with the boiler thermostat left in the normal running position.

## BOILER OVERHEAT PROTECTION

The boiler controls will shut down the boiler in the event of overheating. Should this occur, the following display will appear:

### **Overheat Lockout**

Fill System to 1 Bar  
Bleed Radiators, Refill System  
Check Radiator Valves are Open  
Reset Boiler by pressing r

## LOSS OF SYSTEM WATER PRESSURE

The gauge (K) indicates the central heating system pressure. If the pressure is seen to fall below the original installation pressure of 1-2 bar then conduct the re-pressurising procedure as follows:

Re-pressurise via the filling loop to between 1 & 2 bar (if unsure contact your installer), turn off the tap on the filling loop. Press 'r' button on the control panel to reset the boiler. If unable to do so or if the pressure continues to drop a Gas Safe Registered Engineer or in IE a Registered Gas Installer (RGI) should be consulted.

THE BOILER WILL NOT OPERATE IF THE PRESSURE HAS REDUCED TO LESS THAN 0.3 BAR UNDER THIS CONDITION.



In this case the following display will appear:

**Low Water Pressure**

Fill System to 1 Bar  
Bleed Radiators  
Refill System to 1 Bar

To re-pressurise, follow the procedure above.

**CONDENSATE DRAIN**

This appliance is fitted with a siphonic condensate trap system that reduces the risk of the appliance condensate from freezing. However should the condensate pipe to this appliance freeze, please follow these instructions:

- a. If you do not feel competent to carry out the defrosting instructions below please call your local Gas Safe Registered installer for assistance or in IE a Registered Gas Installer (RGII).
- b. If you do feel competent to carry out the following instructions please do so with care when handling hot utensils. Do not attempt to thaw a condensate drain pipe if you cannot reach it from ground level. Be aware that any water used can quickly freeze if it falls onto pathways, causing a possible slip hazard. If this appliance develops a blockage in its condensate pipe, its condensate will build up to a point where the burner will go out:

**Ignition Lockout**

Check other Gas Appliances work  
If not, re-instate gas supply  
Reset Boiler by pressing r  
If fault persists contact installer

If the appliance is reset it will not light prior to it locking out displaying the above on the display.

To unblock a frozen condensate pipe;

1. Follow the routing of the plastic pipe from its exit point on the appliance, through its route to its termination point. Locate the frozen blockage. It is likely that the pipe is frozen at the most exposed point external to the building or where there is some obstruction to flow. This could be at the open end of the pipe, at a bend or elbow, or where there is a dip in the pipe in which condensate can collect. The location of the blockage should be identified as closely as possible before taking further action.
2. Apply a hot water bottle, microwaveable heat pack or a warm damp cloth to the frozen blockage area. Several applications may have to be made before it fully defrosts. Warm water can also be poured onto the pipe from a watering can or similar. DO NOT use boiling water.
3. Caution when using warm water as this may freeze and cause other localised hazards.
4. Once the blockage is removed and the condensate can flow freely, reset the appliance. (Refer to "To Light the boiler")
5. If the appliance fails to ignite, call your Gas Safe Registered engineer.

**Preventative solutions**

During cold weather, set the boiler stat to maximum, (Must return to original setting once cold spell is over)

Place the heating on continuous and turn the room stat down to 15°C overnight or when unoccupied. (Return to normal after cold spell).

## **ESCAPE OF GAS**

Should a gas leak or fault be suspected contact the National Gas Emergency Service without delay. **Tel. 0800 111 999**

***DO NOT SEARCH FOR GAS LEAKS WITH A NAKED FLAME.***

## **CLEANING**

For normal cleaning simply dust with a dry cloth. To remove stubborn marks and stains, wipe with a damp cloth and finish off with a dry cloth. **DO NOT** use abrasive cleaning materials.

## **MAINTENANCE**

The appliance should be serviced at least once a year by a Gas Safe Registered Engineer or in IE a Registered Gas Installer (RGII).

## **POINTS FOR THE BOILER USER**

**Note.** *In line with our current warranty policy we would ask that you check through the following guide to identify any problems external to the boiler prior to requesting a service engineers visit. Should the problem be found to be other than with the appliance we reserve the right to levy a charge for the visit, or for any pre-arranged visit where access is not gained by the engineer.*

## FAULT FINDING

If a fault occurs then a fault description and suggested potential corrective actions will be displayed. In addition the following information may be useful.

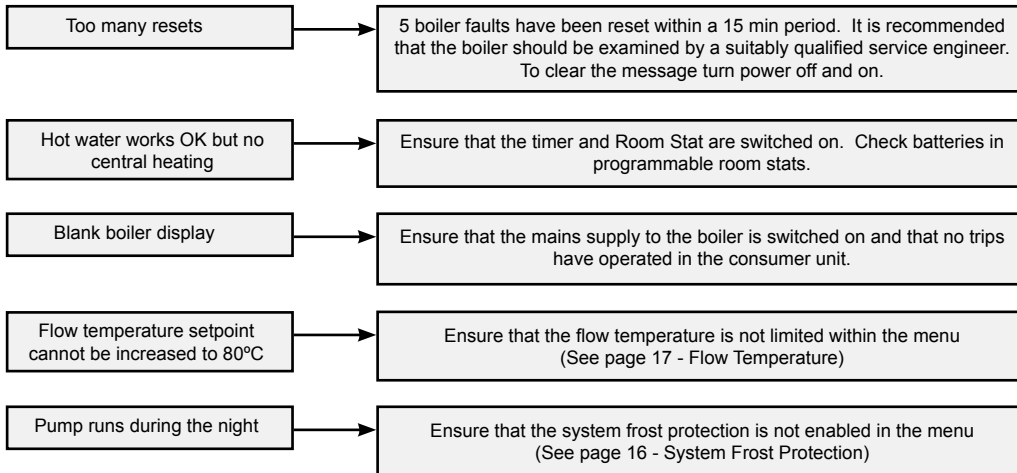



## BOILER CONTROLS

### LEGEND

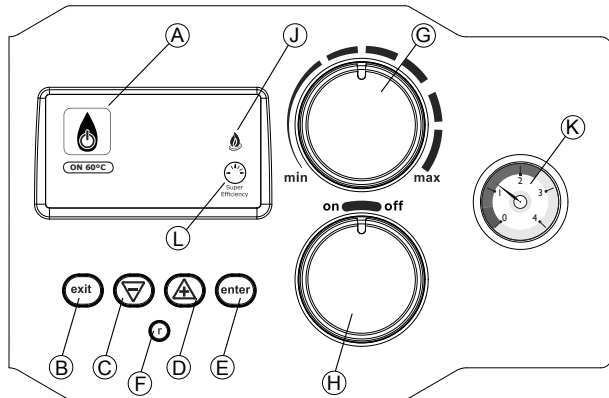







- A. Boiler Status
- B. Exit Button
- C. Down Button
- D. Up Button
- E. Enter Button
- F. Reset Button
- G. CH Temperature Control
- H. On / Off Switch
- J. Burner On indication
- K. Pressure Gauge
- L. Boiler in Full Condensing Mode





## 1 DISPLAY MESSAGES (WITHOUT OUTSIDE SENSOR)

 <b>OFF</b>	Indicates that the Boiler is Switched Off Move the On/Off Switch into the On position to switch the Boiler On
 <b>NO DEMAND</b>	Indicates that either the Timer is Off or the Room Stat and Cylinder Stats are satisfied
 <b>ON 60°C</b>	Indicates that the Boiler is either heating the Radiators or the Hot Water Cylinder



## 2 DISPLAY MESSAGES (WITH OUTSIDE SENSOR)

 <b>OFF</b>	 <b>OFF</b>	Indicates that the Boiler is Switched Off Move the On/Off Switch into the On position to switch the Boiler On
 <b>NO DEMAND</b>		Indicates that either the Hot Water Timer is Off or the Cylinder Stat is Off
 <b>NO DEMAND</b>		Indicates that either the Central Heating Timer is Off or the Room Stat is Off
 <b>ON 60°C</b>		Indicates that the Boiler is heating the Hot Water Cylinder. The water heating the cylinder is at 60°C
 <b>ON 70°C</b>		Indicates that the Boiler is providing Central Heating and that the radiator temperature is 70°C
 <b>4°C</b>	 <b>4°C</b>	Indicates that the pump is running as part of System Frost Protection because the Outside Temperature is less than 5°C. To disable see Page 16.

### 3 DISPLAY MESSAGES (GENERAL)

 <b>4°C</b>	Indicates that the temperature at the boiler is less than 5°C and that the boiler is running to protect itself from frost damage
 <b>NO DEMAND</b>	Indicates system satisfied
Service Due Phone 01482 498704	Indicates that a Service is due To Reset see Page 7.

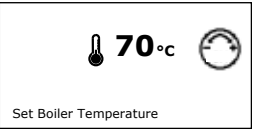
### 4 CHANGE SETTINGS (BASIC)

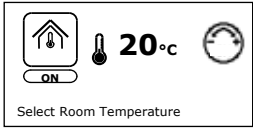
To change the Maximum Boiler Temperature rotate the Boiler Temperature Control This screen will be shown	 Set Boiler Temperature
To switch the boiler On turn the On/Off switch into the On position (H) This screen will be shown	 Boiler Switched On
To disable CH (frost protection still active) turn the On/Off (H) switch into the Off position This screen will be shown	 Boiler Switched Off
To change the Room Temperature Set Point (only if Outside Sensor connected) rotate the Boiler Temperature Control This screen will be shown	 Select Room Temperature

## 5 CHANGE SETTINGS

### Efficiency Level

To view the efficiency level of the boiler press ENTER and the following screen will be displayed.

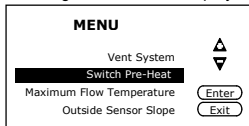

Press "-" until the following screen is displayed.

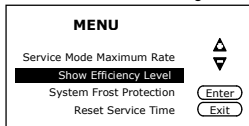

Press ENTER and a screen similar to following will be displayed.

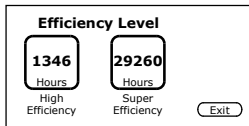

Press EXIT twice to return to normal operation.

### System Frost Protection

This feature can only be accessed if an outside sensor has been connected. The pump will run continuously if the outside temperature is less than 5°C.

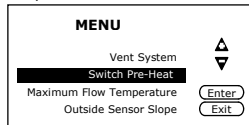

Press "-" until the following screen is displayed.

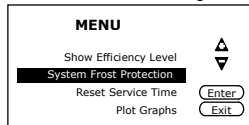

Press ENTER and a screen similar to the following will be displayed.



Press "+" to activate or "-" to de-activate.

Press EXIT twice to return to normal operation.

## 6 CHANGE SETTINGS

### Reset Service Time

If the boiler has not been serviced within the last 12 months then a message will be displayed indicating this. To reset this timing proceed as follows.

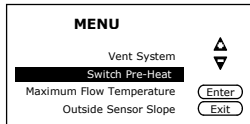

Press "-" until the following screen is displayed.

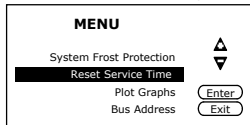

Press ENTER and the following screen will be displayed.

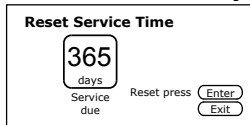

Press ENTER to reset.

Press EXIT to return to normal operation.

### Set Zone 2 Flow Temperature

If an outside sensor is connected to the boiler then the flow temperature target for Hot Water operation can be set independently. Press ENTER and the following screen will be displayed.

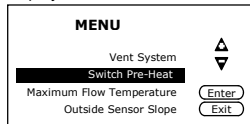

Press "-" until the following screen is displayed.

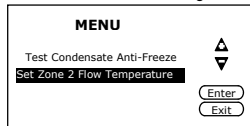

Press ENTER and the following screen will be displayed.

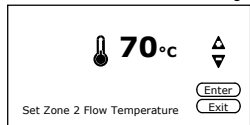

Press "+" & "-" to change the temperature to the required setting and then ENTER. Press EXIT to return to normal operation.









**Ideal Boilers Ltd.**, pursues a policy of continuing improvement in the design and performance of its products. The right is therefore reserved to vary specification without notice.

**Ideal Boilers Ltd.**, P.O. Box 103, National Ave, Kingston Upon Hull, HU5 4JN.  
Tel. 01482 492251 Fax. 01482 448858. Registration No. London 322 137.



**ideal**